



WCDMA Tracker GL300W

User Manual

TRACGL300WUM001

Version:1.00



Document Title	GL300W User manual
Version	1.00
Date	2015-5-25
Status	Release
Document Control ID	TRACGL300WUM001

General Notes

Queclink offers this information as a service to its customers, to support application and engineering efforts that use the products designed by Queclink. The information provided is based upon requirements specifically provided to Queclink by the customers. Queclink has not undertaken any independent search for additional relevant information, including any information that may be in the customer's possession. Furthermore, system validation of this product designed by Queclink within a larger electronic system remains the responsibility of the customer or the customer's system integrator. All specifications supplied herein are subject to change.

Copyright

This document contains proprietary technical information which is the property of Queclink Limited., copying of this document and giving it to others and the using or communication of the contents thereof, are forbidden without express authority. Offenders are liable to the payment of damages. All rights reserved in the event of grant of a patent or the registration of a utility model or design. All specification supplied herein are subject to change without notice at any time.

Copyright © Queclink Wireless Solutions Ltd. 2015

Contents

Contents	2
0. Revision history	3
1. Introduction	0
2. Product Overview	1
2.1. Appearance	1
2.2. Buttons/Mini USB Interface Description	1
2.3. LEDs Description	2
2.4. External Power Interface	2
2.4.1. External DC Charger Interface	2
2.4.2. External Battery Interface	3
2.5. Ignition Detection	3
2.6. External Input Interface	3
3. Getting Started	4
3.1. Parts List	4
3.2. Battery Charging	5
3.3. GL300W External Cable Interface	5
3.4. Turn on/Turn off	6
4. Troubleshooting and Safety info	7
4.1. Troubleshooting	7
4.2. Safety info	7

0. Revision history

Revision	Date	Author	Description of change
1.00	2015/5/25	Hazard.Zhang	Initial

1. Introduction

The water resistant GL300W is a powerful GPS locator designed for lone worker, vehicle, pet and asset tracking applications. The thumb sized button makes this device ideal for applications requiring rapid notification of emergency alert or regular setting of geo-fences based on current location. Its built-in GPS receiver has superior sensitivity and fast time to first fix. Its WCDMA allows the GL300W's location to be monitored in real time or periodically tracked by a backend server and mobile devices. Its built-in 3-axis accelerometer allows motion detection and extends battery life through sophisticated power management algorithms. System integration is straightforward as complete documentation is provided for the full featured @Track protocol. The @Track protocol supports a wide variety of reports including emergency, geo-fence boundary crossings, low battery and scheduled GPS position.

2. Product Overview

2.1. Appearance

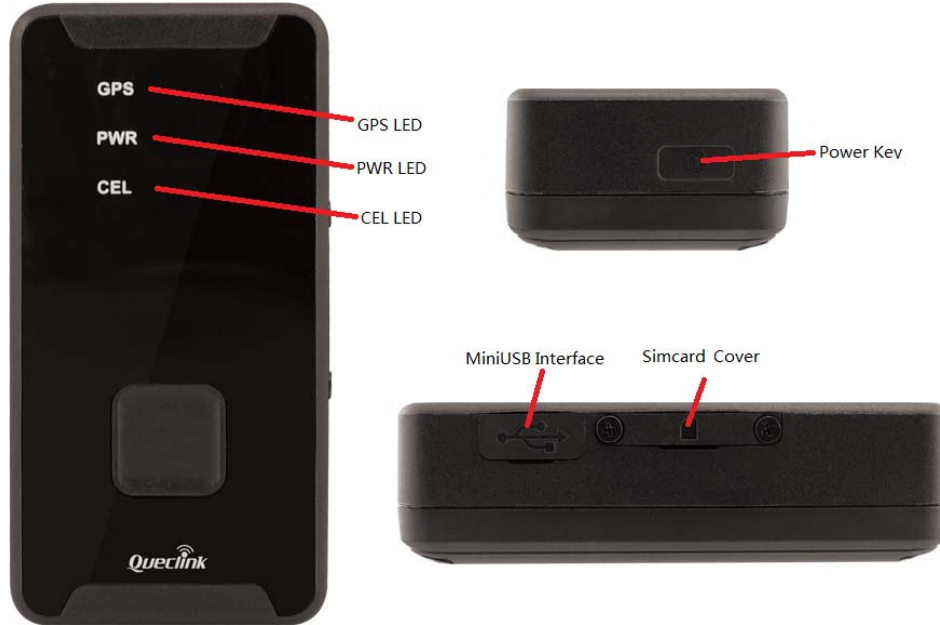

2.2. Buttons/Mini USB Interface Description

Button /Mini USB Interface Description	
Power Key	<ul style="list-style-type: none"> ● Turn on GL300W ● Turn off GL300W when without charging. (If power key is enabled)
Function Key	<ul style="list-style-type: none"> ● Geo-Fence mode Long press the key to enable/disable Geo-Fence ID0 ● Geo-Fence in current position mode Long press the key to enable/disable Geo-Fence ID0. If enable Geo-Fence ID0, using the current position as the center of Geo-Fence 0. ● SOS mode (default) Long press the key to active SOS alarm
Mini USB interface	<ul style="list-style-type: none"> ● Connect a 5V DC adapter can power GL300W and charge the internal battery ● Connect a 3.7V Li-ion or Li-Polymer battery can power GL300W ● Backend server developer or administrator can use the Data_Cable_M to configure GL300W

2.3. LEDs Description

There are three LED in GL300W, the description as following.

LED	Event	State
CELL LED	Searching network	Fast flash
	Network has been registered	Slow flash
	Power off	Dark
	SIM-PIN Locked	Solid
	<LED on> is 2	Dark
GPS LED	GPS has fixed	Solid
	GPS is in fixing	Fast flash
	GPS is on and GPS data wrong	Slow flash
	GPS is off	Dark
	If <LED on> is 0, 150 seconds later after powers on.	Dark
	<LED on> is 2	Dark
PWR LED	Power on and normal	Dark
	Charger inserted and charging completed	Solid
	Charger inserted and charging	Fast flash
	Power key was pressed and prepare to power off	Fast flash
	Abnormal	Fast flash
	Power low alert	Slow flash
	Power off or turn off the power light by command	Dark
	<LED on> is 2	Dark

2.4. External Power Interface

2.4.1. External DC Charger Interface

The Pin2 on Mini-USB connector are used for charging and named as VCHG pin, It can be connected to a 5V DC power supply to power GL300W and charge the internal battery.

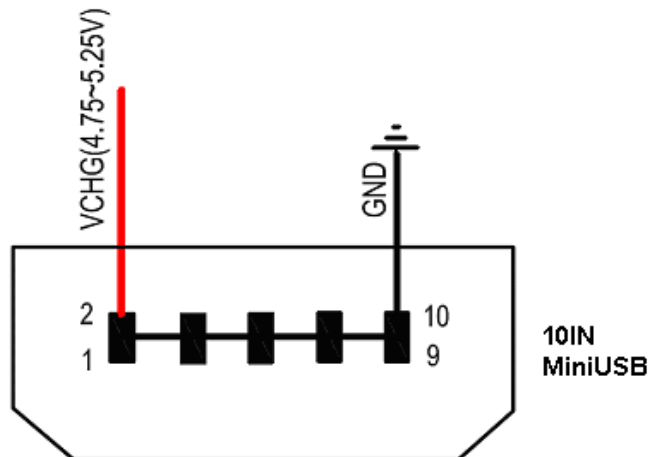

2.4.2. External Battery Interface

The Pin 8 on Mini-USB connector is for external battery and named as EXTBAT pin, It can be connected to 3.7V Li-ion or Li-Polymer battery to power GL300W.

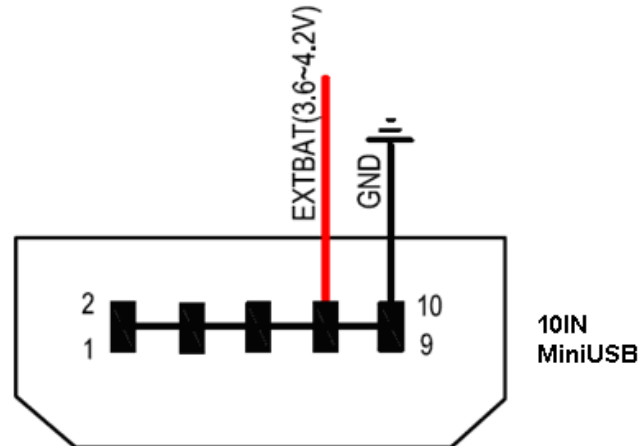

2.5. Ignition Detection

The Pin 7 on Mini-USB connector is for ignition detection when GL300W is used in vehicle tracking application, It is named as IGN_IND pin.

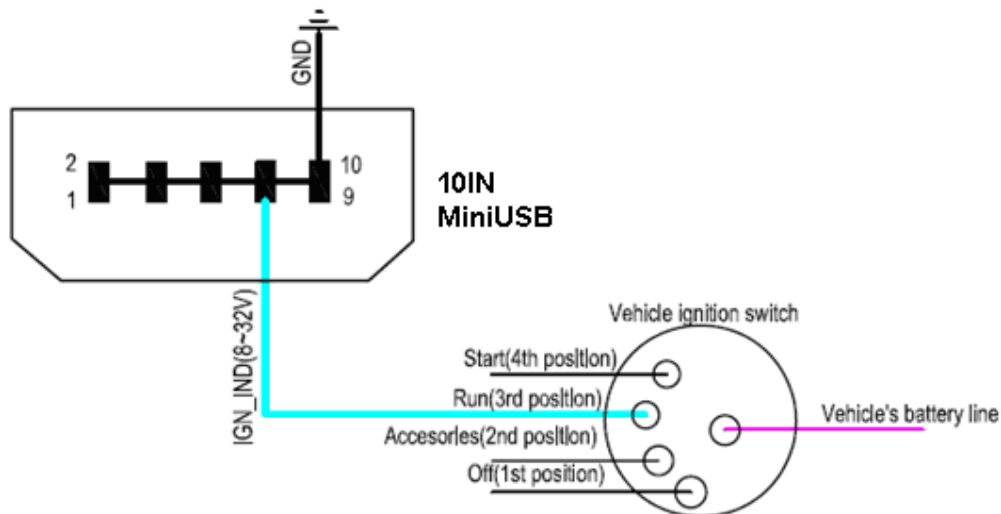

Another easy way is to connect PIN7 to a power output in the fuse box of the vehicle which is only enabled after the vehicle is ignition on. For example: the power output for radio FM.

2.6. External Input Interface

The Pin 5 on Mini-USB connector is a negative trigger input in newer hardware version, It is named as NSW pin.

For negative trigger input the electrical conditions are:

Logical State	Electrical State
Active	0V to 0.8V
Inactive	1.7V to 32V or Open

An input example is shown as following figures:

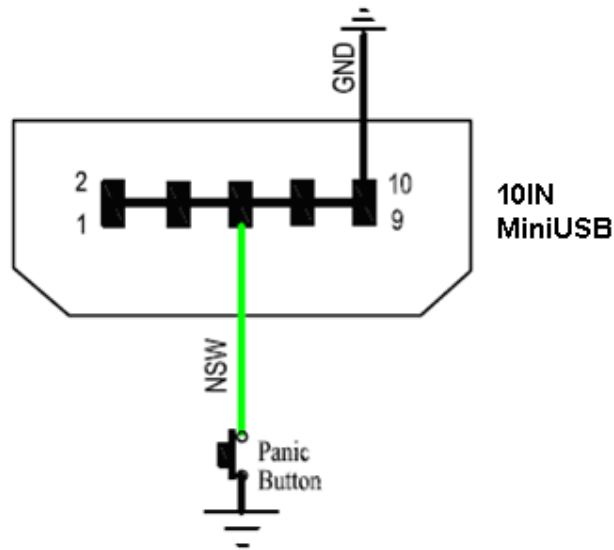



Example of NSW pin connect to a panic button

3. Getting Started

3.1. Parts List

Name	Picture	Remark
GL300W Locater		The WCDMA/GPRS/GPS locator.
AC-DC Power Adapter (Standard accessory)		It is used to charge the internal battery of GL300W.

<p>GL300W Data Cable (Optional accessory)</p>		<p>It is the USB data cable which can be used for firmware upgrading and configuration.</p>
<p>GL300W External Cable (Optional accessory)</p>		<p>It is the extend cable which include the charger interface and external battery interface on GL300W. It also includes the ignition detection interface on the GL300W.</p>

3.2. Battery Charging

- Please connect AC-DC power adapter with GL300W.
- Insert the AC-DC power adapter into the power socket.
- During charging, the PWR LED is flashing fast. When the battery is full charged, the PWR LED will be Ever-light.
- You can also charge the battery by USB cable which connects GL300W with the PC.
- Charging time is about 5 hours.

Note: Before the first time using GL300W, please full charge the battery.

3.3. GL300W External Cable Interface

- GL300W External Cable is a cable with a Mini USB connector and six wires which include the external power interface, ignition detect and input interface for GL300W. Please find the detail description in following table.

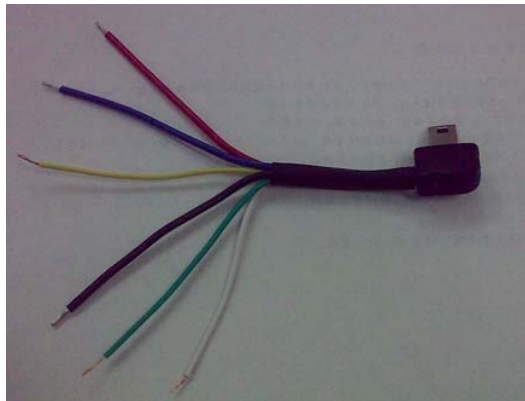

Color	Name	Remark
RED	External DC IN (5V)	Please refer to 2.4.1 for detail
Black	Ground	Please refer to 2.4.1 for detail
Blue	External Battery IN (DC 3.4V to 4.2V)	Please refer to 2.4.2 for detail

White	Ignition Detect	Please refer to 2.5for detail
Green	NSW (negative trigger input)	Please refer to 2.6 for detail

3.4. Turn on/Turn off

- Turn on:
 - ◆ Method 1: Press the Power key at least 3 seconds and release it to turn on GL300W. At the same time, PWR LED will light on.
 - ◆ Method 2: Connect device to charger or external battery, and it will turn on automatically, PWR LED will light on.
- Turn off:
 - ◆ Method 1: Press the power key about 2 seconds; PWR LED will fast flash and then turn off, it indicates that GL300W is turned off. The time of power off is depended on the quality of network. The maximum time of power off is 90 seconds. It is only valid to turn off when using internal battery. Please note the end-user can not power off GL300W when the power key is disabled by protocol.
 - ◆ Method 2: If using external battery, device will power turn-off when external battery disconnect.

4. Troubleshooting and Safety info

4.1. Troubleshooting

Trouble	Possible Reason	Solution
After GL300W is turned on, the WCDMA LED flashes quickly always.	The signal is too weak; GL300W can't register to the network.	Please move GL300W into place with good WCDMA coverage.
Messages can't be reported to the backend server by GPRS.	APN is wrong. Some APN cannot visit the internet directly.	Ask the network operator for the right APN.
	The IP address or port of the backend server is wrong.	Make sure the IP address for the backend server is an identified address in the internet.
Unable to power off GL300W.	The function of power key was disabled by AT+GTFKS.	Enable the function of power key by AT+GTFKS.
	Unable to power off GL300W if charger connected or using external battery.	Disconnect charger or external battery, and try again.
No response from UART when configure GL300W through UART	GL300W is in power saving mode.	Remove the Data_Cable_M, and plug it in again. After this operation, GL300W will exit from power saving mode for 10 seconds.
		Re-try GL300W manager tool again, it will try to wake up device.
GL300W can't get successful GPS fixing.	The GPS signal is weak.	Please move GL300W to a place with open sky.
		It is better to let the top surface face to sky. (The same surface with indication LED)

4.2. Safety info

- Please do not disassemble the device by yourself.
- Please do not put the device on the overheating or too humid place, avoid exposure to direct sunlight. Too high temperature will damage the device or even cause the battery explosion.
- Please do not use GL300W on the airplane or near medical equipment.

WARNING:

This device complies with part 15 of the FCC Rules. Operation is subject to the following two conditions:

- (1) This device may not cause harmful interference, and
- (2) This device must accept any interference received, including interference that may cause undesired operation. Changes or modifications not expressly approved by the party responsible for compliance could void the user's authority to operate the equipment.

NOTE:

This equipment has been tested and found to comply with the limits for a Class B digital device, pursuant to part 15 of the FCC Rules. These limits are designed to provide reasonable protection against harmful interference in a residential installation.

This equipment generates, uses and can radiate radio frequency energy and, if not installed and used in accordance with the instructions, may cause harmful interference to radio communications. However, there is no guarantee that interference will not occur in a particular installation. If this equipment does cause harmful interference to radio or television reception, which can be determined by turning the equipment off and on, the user is encouraged to try to correct the interference by one or more of the following measures:

- Reorient or relocate the receiving antenna.
- Increase the separation between the equipment and receiver.
- Connect the equipment into an outlet on a circuit different from that to which the receiver is connected.
- Consult the dealer or an experienced radio/TV technician for help.

RF Exposure Information and Statement:

The SAR limit of USA (FCC) is 1.6 W/kg averaged over one gram of tissue, and the SAR limit of Eu (CE) is 2 W/kg averaged over one gram of tissue.

Device types: GL300W (FCC ID:YQD-GL300W) has also been tested against this SAR limit.

The highest SAR value reported under this standard during product certification for use on the body is 1.375W/kg for 1g(FCC) and for 10g(CE) is 0.857W/kg.

The safety distance is 6.2cm for this device.